

PULSE REFLEX™

The product of intuition



- ▶ EASY-TO-USE
- ▶ POWERFUL
- ▶ OPEN
- ▶ CONSISTENT

www.bksv.com/pulsereflex

PULSE Reflex – the product of intuition

PULSE Reflex is a Workflow

PULSE Reflex is a workflow strategy that we apply to test and measurement software to create consistent, high-performance applications that are intuitive to use and that openly share data in a PC environment.

PULSE Reflex aims to make the next step in the workflow process obvious and intuitive.

PULSE Reflex is a Concept

PULSE Reflex is designed to be easy-to-use by standardising the user interface components and emphasising only the most commonly used features.

PULSE Reflex is a major evolutionary step in the development of the world's most popular sound and vibration platform, PULSE. Designed in close cooperation with end-users from diverse sectors of industry around the globe, PULSE Reflex has ease of use and high productivity at its heart.

PULSE Reflex is an Environment

PULSE Reflex is designed to optimise your workflow so you can share data across applications and vendors, visualise results quickly, and create high quality reports with ease.

With PULSE Reflex, functionality is at your fingertips. Common operations are grouped together in dedicated regions of the screen. You control whether they are visible or hidden to give you maximum focus and screen space for whatever task you are performing.

PULSE Reflex enables you to centralise and organise all your knowledge and information on the project at hand.

PULSE Reflex is a Collaboration Tool

PULSE Reflex has an architecture that allows multiple users working on different aspects of a problem to collaborate and share data and results.

Take notes as you go along and record every thought as it occurs using the versatile but simple to use notes section. You can include sounds, photographs, or videos and link them to items in your project to provide a lasting reminder of how or why critical decisions were made.



"Intuition becomes increasingly valuable in the new information society precisely because there is so much data."

John Naisbitt, international best-selling author of "Megatrends"

PULSE REFLEX™
The Product of Intuition



Easy, powerful, open and consistent



PULSE Reflex is Easy-to-use

- ▶ The intuitive user interface puts the tools you need at your fingertips.
- ▶ The easy-to-follow workflow model leads you through the process, whatever your application.

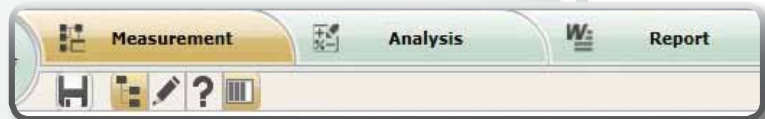

PULSE Reflex is Powerful

- ▶ The architecture accommodates high volumes of data allowing swift searching, sorting and filtering of large and complex projects.
- ▶ Display data the way you want. From individual graphs to multiple pages, define your display strategy in advance to get the best from your analysis, or to support your own in-house procedures.

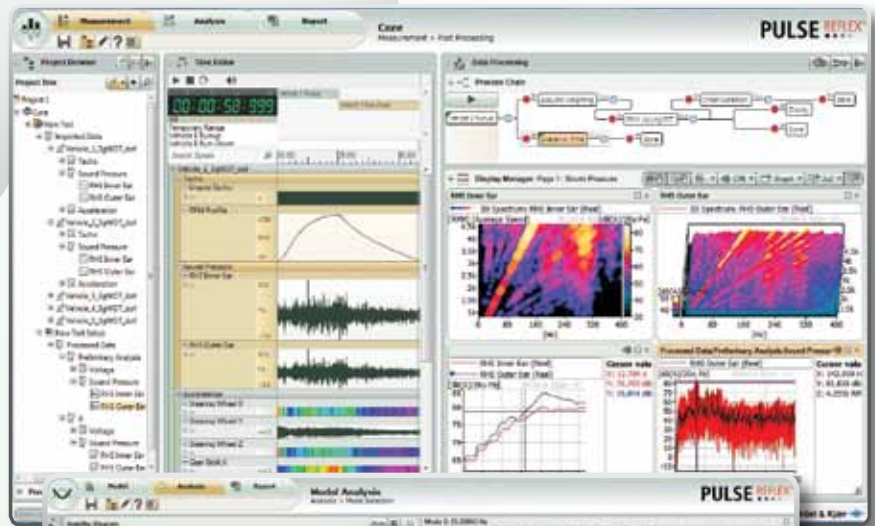

PULSE Reflex is Open

- ▶ The open data policy supports a wide range of native and third party data formats for import and export.
- ▶ PULSE and Test for I-deas data are imported seamlessly, and reports are generated in Word, Excel or PowerPoint –the choice is yours.

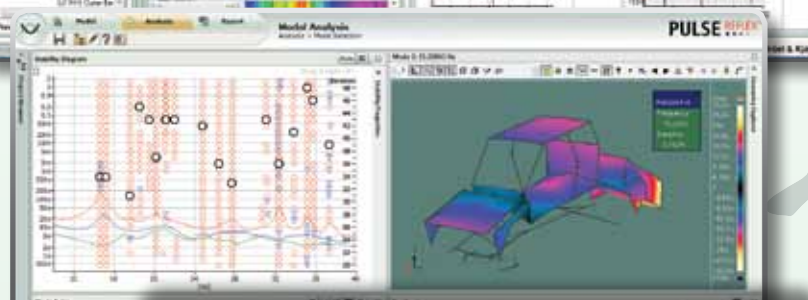

PULSE Reflex is Consistent

- ▶ The common user interface elements are maintained between applications making learning of new applications faster.
- ▶ Related operations are grouped together in dedicated regions of the screen. You control whether they are visible, or hidden, for maximum focus and screen space.

ModelID	Damped Frequency (Hz)	Damping(%)	Complexity	Parameter Estimation Method
1	14.63367	2.05134	0.05775	Rational Fraction Polynomial-Z
2	15.21843	2.10209	0.08533	Rational Fraction Polynomial-Z
3	17.542	2.70688	0.12664	Rational Fraction Polynomial-Z

DOF L	Units	Magnitude	Phase	Real	Imaginary
1013+	m	7.7714E-06	-1.95855	-2.794E-06	-9.2518E-06
1021+	m	4.5182E-07	-2.77139	-4.2124E-07	-1.6339E-07



PULSE Reflex Core

The nucleus for off-line processing

PULSE Reflex Core is the nucleus of the application suite for off-line processing of stored time-domain and frequency-domain data.

From troubleshooting to routine testing, PULSE Reflex Core brings high efficiency, high productivity and high quality results.

You can quickly view and listen to large volumes of time data across multiple recordings or select sections of time-data for further processing, such as filtering, statistical analysis, spectral analysis and order analysis.

Take notes and link them to your data to remind you of key decisions or critical project issues.

Display your results at each stage of the process and link them to your report as you go along.



Increase your productivity

- ▶ PULSE Reflex is so easy to use that you can progress from a new, to an intermediate and then expert user with a minimal amount of training.
- ▶ Maximise your productivity with an efficient, almost limitless time-data handling capacity – whether you're editing, filtering or analysing.
- ▶ Versatile and simple to set up, you can display and compare data from different sources to validate the results of your tests and analyses.
- ▶ PULSE Reflex puts all your sound and vibration data at your fingertips, whether from existing PULSE projects, Test for I-deas, or third party systems.

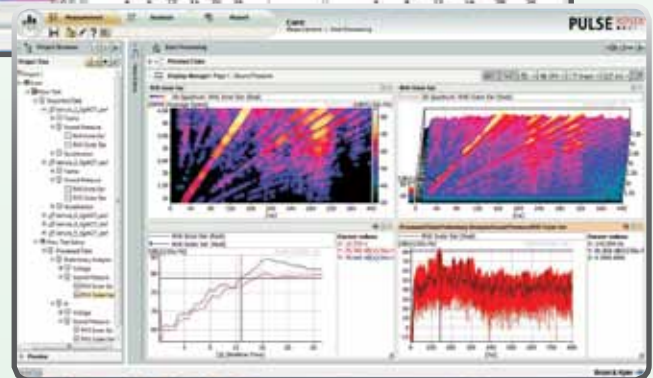
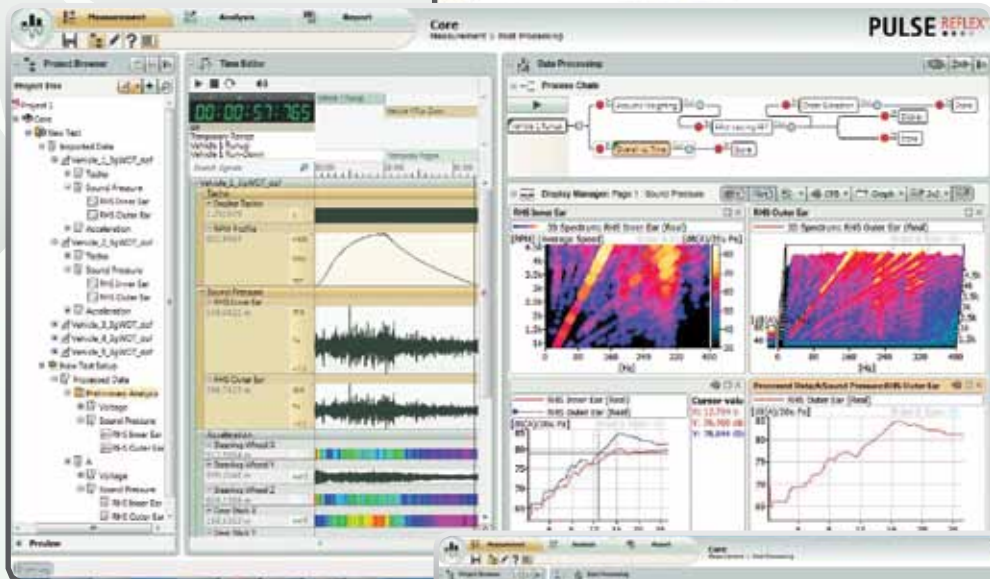
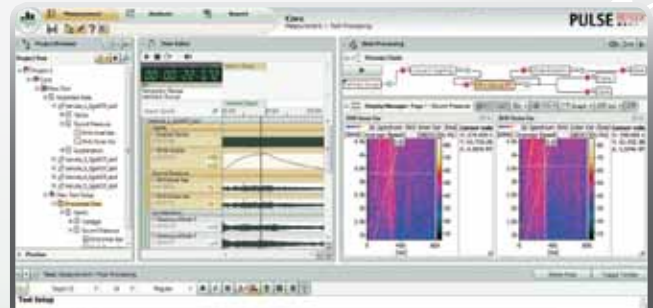

Powerful, yet easy to use

- ▶ Simplify the creation and control of your analysis process using a graphical representation of functional elements, such as tachometer processing, FIR filtering, FFT analysis and order analysis.
- ▶ Quickly and easily perform sophisticated data analysis. For standard, yet complex post-processing applications, such as time-varying data analysis, specialised super-elements help you combine functional elements in a predefined way.
- ▶ Refine your results in the scratchpad calculator using a wide range of mathematical, statistical and editing functions.



PULSE Reflex Modal Analysis

Brüel & Kjær is a leading supplier of complete modal analysis solutions ranging from impact test systems with a single hammer and accelerometer to large multi-shaker systems with hundreds of accelerometers. From troubleshooting and benchmarking to design and model validation, applying the PULSE Reflex concept to modal analysis gets you accurate results in a quick and easy way. PULSE Reflex Modal Analysis guides you efficiently through measurement validation, parameter estimation setup, mode selection, analysis validation and reporting.



Courtesy of CTAG



Courtesy of CTAG

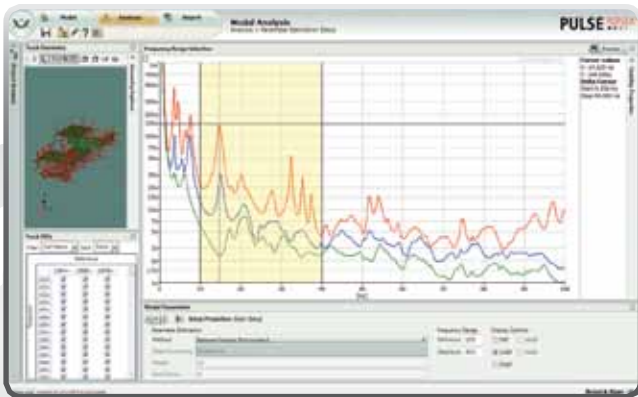

Make decisions based on results you can trust

- ▶ Get accurate and reliable results even in the most demanding situations with a targeted set of “best-in-class” mode indicator functions and curve-fitters. With the right curve-fitter at hand, weakly excited modes, heavily damped modes, repeated roots and inconsistent FRF data are no longer an issue.
- ▶ Produce quality results with confidence by taking advantage of powerful analysis tools such as cluster diagrams, pole density diagrams and complexity plots to validate your modal results.

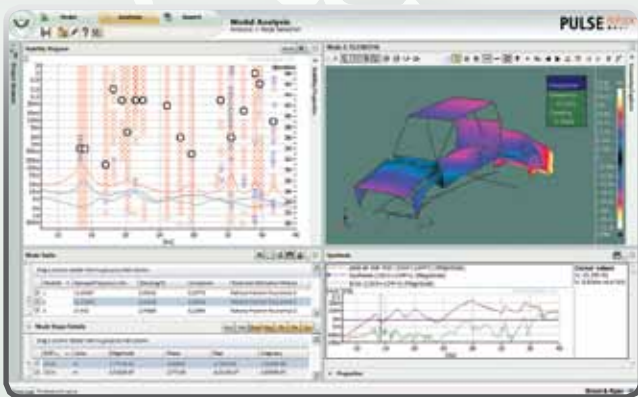

Advanced modal analysis made simple

- ▶ For fast and straightforward selection of true physical modes, clear stabilisation diagrams make it easy, even for the new or infrequent user.
- ▶ Maintain high productivity when conducting repetitive testing and investigations of unknown structures with automated mode selection, and eliminate user-dependent results.

Maximise your investment by tailoring your solution

- ▶ Select the optimal solution from Brüel & Kjær’s complete and fully integrated measurement chain, which includes accelerometers, modal shakers, impact hammers, data acquisition front-ends and measurement and post-processing software.
- ▶ The openness and flexibility of PULSE Reflex Modal Analysis supports your needs today and in the future. You are never limited to a vendor specific system configuration and can easily assemble the system of your choice.

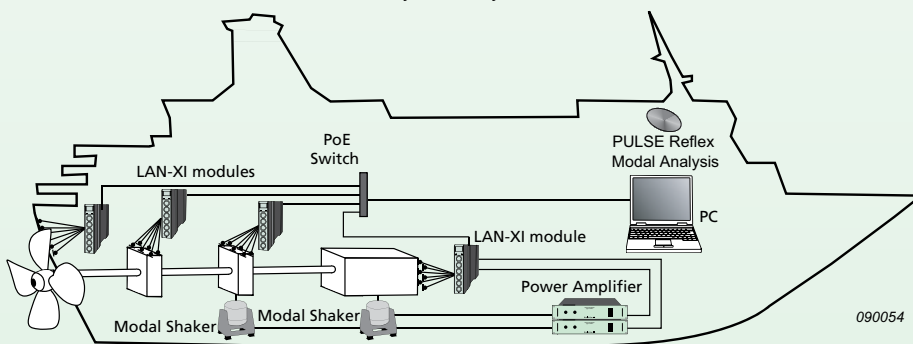

PULSE Reflex Building Acoustics

Store, analyse, report – quickly

- ▶ The PULSE Reflex concept applied to our building acoustics solution enables you to store, review, compare, analyse and report your field and laboratory sound insulation results faster.

Combine, compare, conclude

- ▶ Determining the before-and-after performance of a rebuilt or repaired party wall is intuitively simple using the interactive display to instantly reveal what is contributing to your sound insulation results.



Comply with Standards

- ▶ The PULSE Reflex intuitive data analysis capability gives you peace of mind, ensuring that measurements and reports, published in one of 15 languages in Microsoft® Word, Excel or PowerPoint, comply with national and international building acoustics standards.

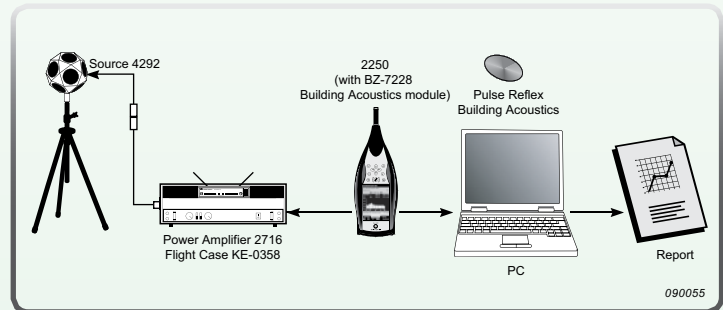

Brüel & Kjær helps people to feel at ease with their surroundings. Over the last 65 years, we have listened to, felt, measured and analysed sound and vibration in homes, industry and the local environment. We help you solve your challenges with innovative, precision instrumentation. Our comprehensive portfolio of over 3000 products ranges from single transducers to complete structural testing measurement and analysis systems.